

**HAYMAN REESE**  
PART No: **R2711W**  
**BMW X1 04-2010 on**

## INSTALLATION INSTRUCTIONS

PLEASE ENSURE THAT INSTRUCTIONS UNDERSTOOD PRIOR TO FITMENT



Installation Time: Approx **30** Mins

**Towbar Installation Instructions**  
**BMW X1 04/2010 on**

**Towbar capacity**

**Part Number **R2711W****

**Max Towing Braked 1400kg**  
**Max Static Ball Load 140kg**

Hayman Reese (Cequent)  
PO Box 4050, Dandenong South VIC 3164  
Phone 1800 812 017 Email [info@haymanreese.com.au](mailto:info@haymanreese.com.au)

# HAYMAN REESE

PART No: R2711W

BMW X1

## INSTALLATION INSTRUCTIONS

PLEASE ENSURE THAT INSTRUCTIONS UNDERSTOOD PRIOR TO FITMENT

### Warning:

1. Do not, drill, cut, weld or otherwise modify the towbar.
2. If you are using electric welding on a motor vehicle, **always** check that the vehicle is not equipped with electronic engine or instrument management equipment. Failure to do so could **destroy** any onboard computers. If in doubt, check with the vehicle's manufacturer.

### General:

1. Ensure all hardware items have been included refer to assembly diagram.
2. It is recommended that the instructions are read through and completely understood before making any attempt to fit this product.
3. Be wary of any changes to vehicle designs or other accessories that may conflict with the installation of this product.
4. Before drilling ensure that the area is clear of fuel, electrical & other components.
5. All holes drilled into the body panels shall have all burrs & swarf removed then coated with a suitable rust preventative paint.
6. The high tensile fasteners supplied with this product were used to achieve the specified rating. If replacement is required ensure that fasteners of the same rating & quality are used. Contact an authorised **Hayman Reese** dealer if further information is required.
7. Ensure that all hardware is fastened to torque list below check fasteners on regular basis.
8. Towbar load rating sticker provided with this product shall be conspicuously located on inside rear end of the driver's door. **(See diagram below).**
9. Hayman Reese recommends that you check your tow ball to ensure that it complies with the Australian standards **AS 4177.2**.
10. **PLEASE NOTE:** It is advised to remove your lug or tbm when not actually towing so as to produce a clear view of the vehicles registration plate if obscured, and to also provide maximum available departure angle.

### Tow bar Maintenance and Care.

Hayman Reese recommends that bolt torque's, as listed below, are routinely and regularly inspected and checked for correct tension. Replace any worn or defective parts.

We recommended to remove Tow Ball Mounts (TBM's, tongues or lugs) when not being used for any considerable length of time.

So as to avoid injury, when not towing it is suggested that the tongue, Pull Pin and R-clip are removed then stored in a safe, clean and dry place, away from excessive moisture.

Hitch Pull Pins and spring "R" clips are regularly checked for proper installation. Replace any worn or defective parts.

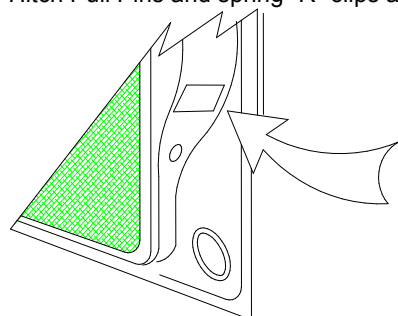

Place load rating sticker  
inside driver's door here

### **RECOMMENDED ASSEMBLY TORQUE LISTING**

#### Diameter Grade 8.8 Bolt

M6	9.5 Nm
M8	21.7 Nm
M10	43.4 Nm
M12	77.3 Nm
M14	146 Nm
M16	189.8 Nm

### **FOR TOWING PURPOSES ONLY**

For towing capacity details please refer to vehicle owner's manual or to the manufacturer. Overloading can void your warranties.

# HAYMAN REESE

PART No: R2711W

BMW X1

## INSTALLATION INSTRUCTIONS

PLEASE ENSURE THAT INSTRUCTIONS UNDERSTOOD PRIOR TO FITMENT

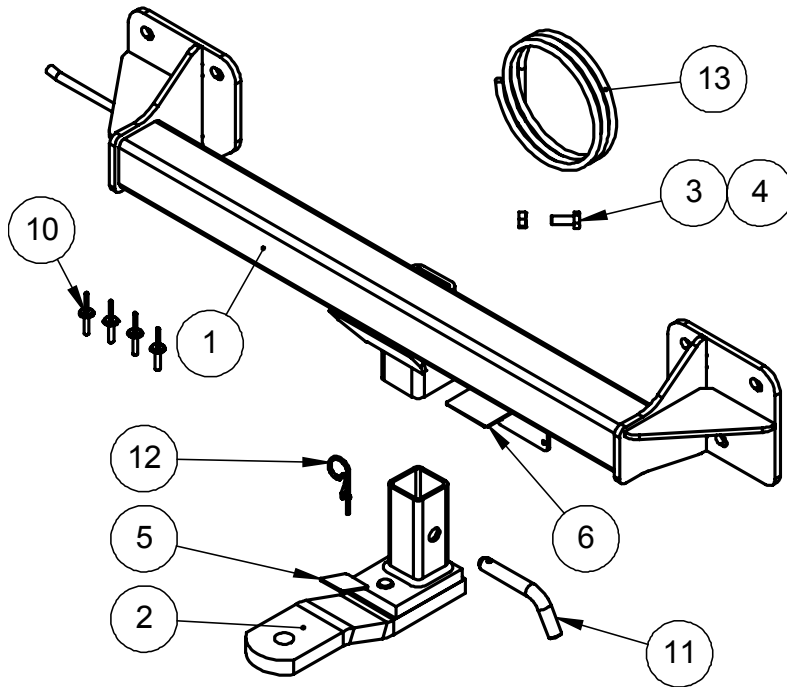

QTY.	DESCRIPTION	ITEM NO.
1	BMW X1 WELD ASSY.	1
1	TBM ASSEMBLY	2
1	BOLT M10-1.50 x 25	3
1	NUT HX M10 - 1.5 Z/P	4
1	HAYMAN REESE LOGO STICKER	5
1	CP STICKER	6
1	FITTING INSTRUCTION	7
1	Warranty Card	8
1	LOAD RATING LABEL	9
4	Wheel Well Skrivet	10
1	PULL PIN	11
1	SPRING COTTER PIN	12
1	WIRING LOOM	13





## HAYMAN REESE

PART No: R2711W

BMW X1

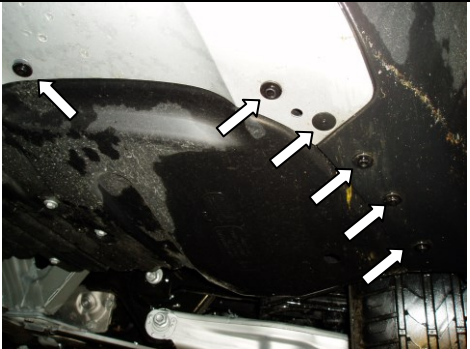
### INSTALLATION INSTRUCTIONS

PLEASE ENSURE THAT INSTRUCTIONS UNDERSTOOD PRIOR TO FITMENT

	<ol style="list-style-type: none"><li>1. Remove 12 screws under the bumper.</li></ol>
	<ol style="list-style-type: none"><li>2. Remove 2 screws and plastic rivet inside wheel arch on both sides.</li></ol>
	<ol style="list-style-type: none"><li>3. Lift plastic wheel flare to remove screw on both sides</li><li>4. Remove tail light assembly on both sides</li><li>5. Flex bumper skin to remove, disconnect any wiring attached to bumper skin.</li></ol>
	<ol style="list-style-type: none"><li>6. Remove and discard impact beam.</li><li>7. Fit towbar using factory nuts.</li><li>8. Torque all nuts to specification.</li><li>9. Refit muffler mount.</li><li>10. Refit bumper bar and tail light assembly.</li></ol>

**HAYMAN REESE**  
**PART No: 100854-WL**  
**BMW X1, 3 Series, X5, X6**

## **INSTALLATION INSTRUCTIONS**

PLEASE ENSURE THAT INSTRUCTIONS ARE UNDERSTOOD PRIOR TO FITMENT

### **Wiring Loom Installation Instructions**

## **BMW X1, 3 Series, X5, X6**

**Part No: 100854-WL**

**X1, X5, X6 Tail Harness Length Required: 1800mm**

**3 Series Tail Harness Length Required: 1200mm**

**ECU Required For X1 (2009 - 2011), X5, X6: 04829**

**ECU Required for X1 (2011 - Onwards), 3 Series: 04838**

**X1 - Pages 2 - 6**

**3 Series - Pages 7 - 11**

**X5 & X6 - Pages 12 - 16**

**Wiring Loom Installation Time: Approx. 50 minutes**

Issue Date 10-12-13

Page 1

Part No: 100854-WL

Hayman Reese (Cequent)  
PO Box 4050, Dandenong South VIC 3164  
Phone 1800 812 017 Email [info@haymanreese.com.au](mailto:info@haymanreese.com.au)



[www.haymanreese.com.au](http://www.haymanreese.com.au)

**HAYMAN REESE**  
**PART No: 100854-WL**  
**BMW X1, 3 Series, X5, X6**

**INSTALLATION INSTRUCTIONS**

PLEASE ENSURE THAT INSTRUCTIONS ARE UNDERSTOOD PRIOR TO FITMENT

The following steps are for BMW X1 models only. For 3 Series models, please proceed to page 7. For X5 & X6, please proceed to page 12.

1. In the luggage compartment, remove the floor cover carpet (1).



2. Remove the storage compartment tray (1).



3. Remove the rear luggage compartment trim (1) by first removing the fasteners from the cargo hook tie-downs (2).

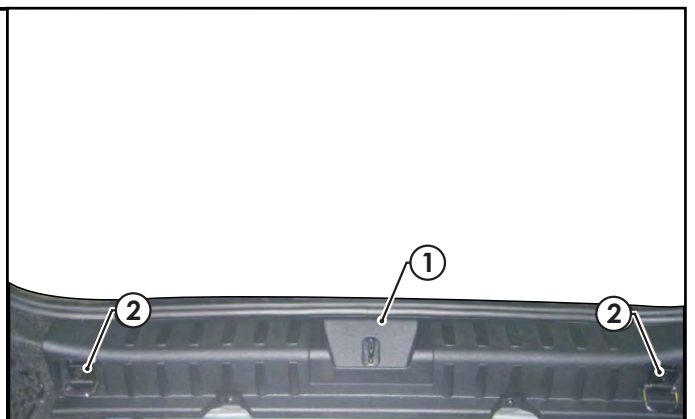

Issue Date 10-12-13

Page 2

Part No: 100854-WL

Hayman Reese (Cequent)  
PO Box 4050, Dandenong South VIC 3164  
Phone 1800 812 017 Email [info@haymanreese.com.au](mailto:info@haymanreese.com.au)

[www.haymanreese.com.au](http://www.haymanreese.com.au)



**HAYMAN REESE**  
**PART No: 100854-WL**  
**BMW X1, 3 Series, X5, X6**

**INSTALLATION INSTRUCTIONS**

PLEASE ENSURE THAT INSTRUCTIONS ARE UNDERSTOOD PRIOR TO FITMENT

4. On the RHS of the luggage compartment, remove the access panel cover (1).



5. Route the trailer patch (P/No: 100854-WL) (1) underneath the RHS side trim towards the RHS tail light assembly connector (2).



6. On the LHS of the luggage compartment, remove the storage compartment (1).
7. Underneath the storage compartment, remove the vehicle grommet (2).
8. Drill the grommet hole out to Ø30mm. File any rough or sharp edges and spray on rust inhibitor.



Issue Date 10-12-13

Page 3

Part No: 100854-WL

Hayman Reese (Cequent)  
PO Box 4050, Dandenong South VIC 3164  
Phone 1800 812 017 Email [info@haymanreese.com.au](mailto:info@haymanreese.com.au)

**HAYMAN REESE**  
**PART No: 100854-WL**  
**BMW X1, 3 Series, X5, X6**

**INSTALLATION INSTRUCTIONS**

PLEASE ENSURE THAT INSTRUCTIONS ARE UNDERSTOOD PRIOR TO FITMENT

9. Following the table below, connect the ezy-taps (1) to the vehicle harness wires (2), then connect the trailer harness terminals (3) to the corresponding wires (2).

Function	Trailer Patch	Vehicle Connector
R.IND	GREEN/BLACK	BLUE/BROWN
REVERSE	BLACK/WHITE	BLACK/PURPLE
TAIL/BRAKE	BROWN/BLACK	BLACK/BLUE
	X1 / 3 SERIES	

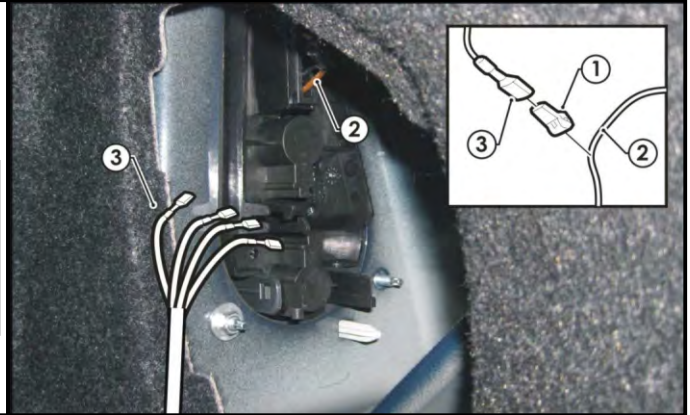

10. Route the trailer patch across the rear of the luggage compartment towards the LHS of the vehicle.

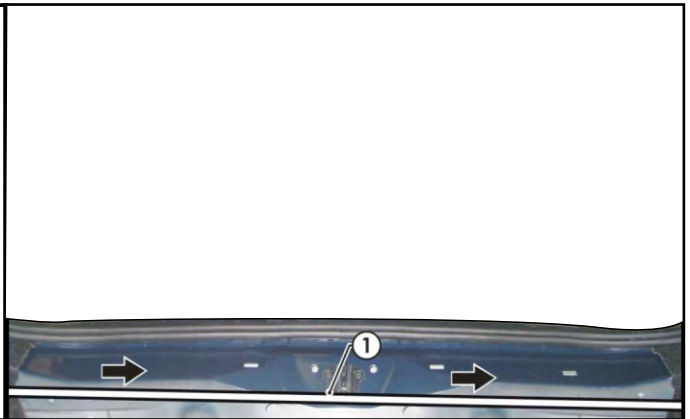

11. Following the table below, connect the ezy-tap (1) to the vehicle harness wire (2) then connect the trailer harness terminal (3) to the corresponding wire (2).

Function	Trailer Patch	Vehicle Connector
L.IND	YELLOW / BLACK	BLUE / GREEN

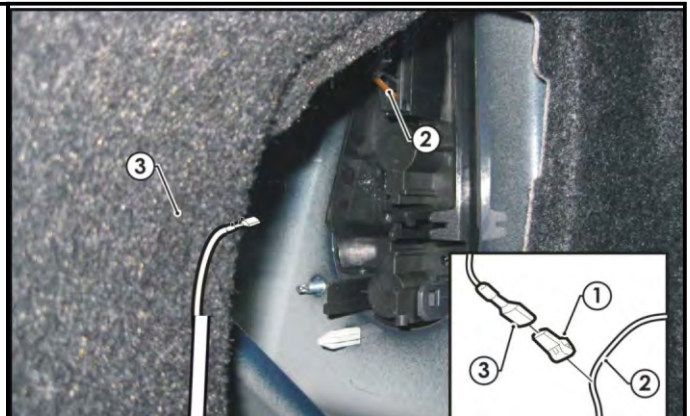

Issue Date 10-12-13

Page 4

Part No: 100854-WL

Hayman Reese (Cequent)  
 PO Box 4050, Dandenong South VIC 3164  
 Phone 1800 812 017 Email [info@haymanreese.com.au](mailto:info@haymanreese.com.au)



**HAYMAN REESE**  
**PART No: 100854-WL**  
**BMW X1, 3 Series, X5, X6**

**INSTALLATION INSTRUCTIONS**

PLEASE ENSURE THAT INSTRUCTIONS ARE UNDERSTOOD PRIOR TO FITMENT

12. Connect the trailer patch power ring terminal (1) to the vehicle battery positive terminal (2).
13. Connect the trailer patch ground ring terminal (3) to the vehicle battery negative terminal (4).

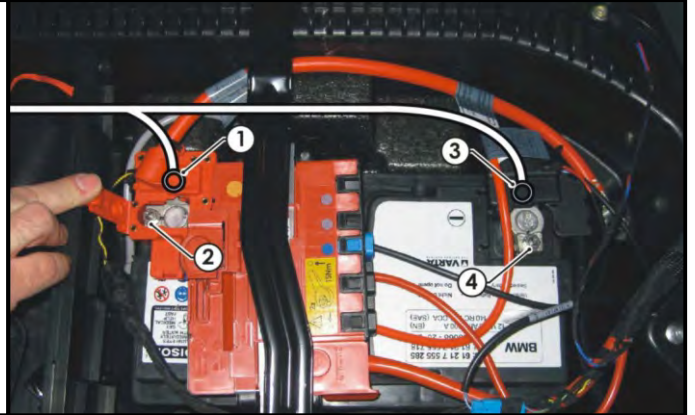

14. Connect the trailer patch 12-way connector (1) to the ECU (2).

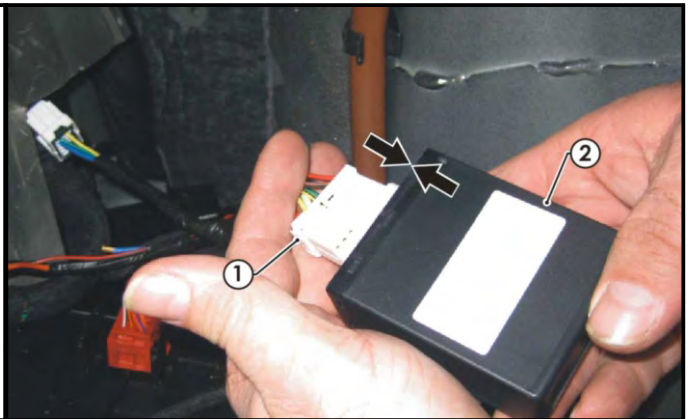

15. Slot the ECU (1) into one vacant slot on the RHS foam compartment.

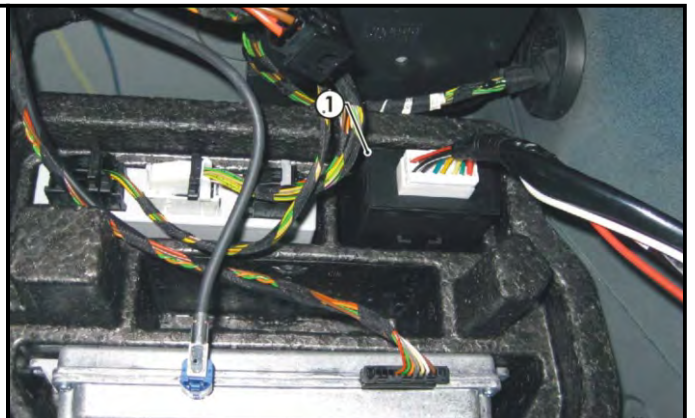

Issue Date 10-12-13

Page 5

Part No: 100854-WL

Hayman Reese (Cequent)  
PO Box 4050, Dandenong South VIC 3164  
Phone 1800 812 017 Email [info@haymanreese.com.au](mailto:info@haymanreese.com.au)

[www.haymanreese.com.au](http://www.haymanreese.com.au)



**HAYMAN REESE**  
**PART No: 100854-WL**  
**BMW X1, 3 Series, X5, X6**

**INSTALLATION INSTRUCTIONS**

PLEASE ENSURE THAT INSTRUCTIONS ARE UNDERSTOOD PRIOR TO FITMENT

16. Route the tail harness (tail length 1800mm) (1) through the previously drilled out grommet hole towards the towbar.
17. Mount the trailer socket (2) to the towbar mounting bracket using M4 fasteners (not supplied).
18. Ensure the tail harness grommet is seated correctly and secure in place using a cable tie (not supplied).



19. Connect the trailer patch 8-way connector (1) to the tail harness mating connector (2).

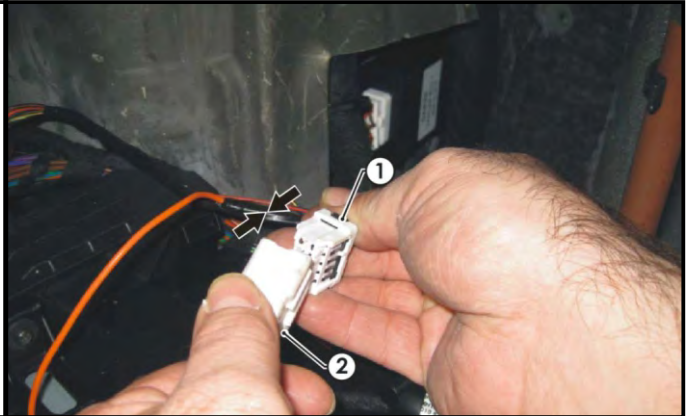

20. Test the trailer harness function using a Light Board or multimeter.
21. Secure all harness using cable ties (not supplied).
22. Re-fit removed parts and secure all fasteners, ensuring there are no squeaks or rattles.
23. Place instructions in glove box after fitment.

Issue Date 10-12-13

Page 6

Part No: 100854-WL

Hayman Reese (Cequent)  
PO Box 4050, Dandenong South VIC 3164  
Phone 1800 812 017 Email [info@haymanreese.com.au](mailto:info@haymanreese.com.au)

[www.haymanreese.com.au](http://www.haymanreese.com.au)



**HAYMAN REESE**  
**PART No: 100854-WL**  
**BMW X1, 3 Series, X5, X6**

**INSTALLATION INSTRUCTIONS**

PLEASE ENSURE THAT INSTRUCTIONS ARE UNDERSTOOD PRIOR TO FITMENT

The following steps are for BMW 3 Series models only. For X1 models, please refer to page 2. For X5 & X6, please proceed to page 12.

1. In the luggage compartment, remove the floor carpet cover (1).



2. Remove the rear luggage compartment trim (1) by first removing the two screws (2) and the four clips (3).

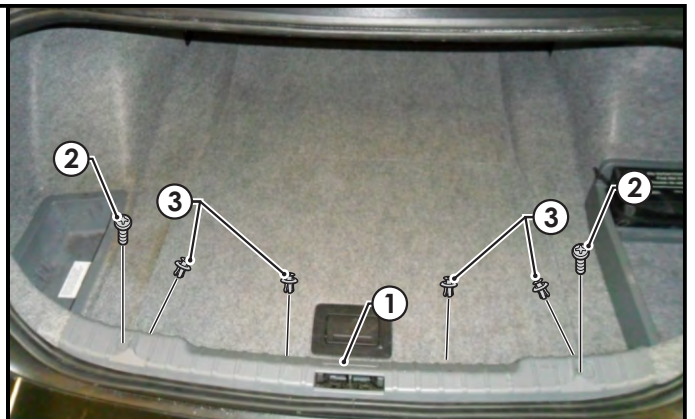

3. On the RHS of the luggage compartment, locate the indicated clip (1), turn 90° to release and remove the storage tray (2).
4. Remove the two fasteners (3) and dislodge the luggage compartment trim (4).

Repeat for the LHS.

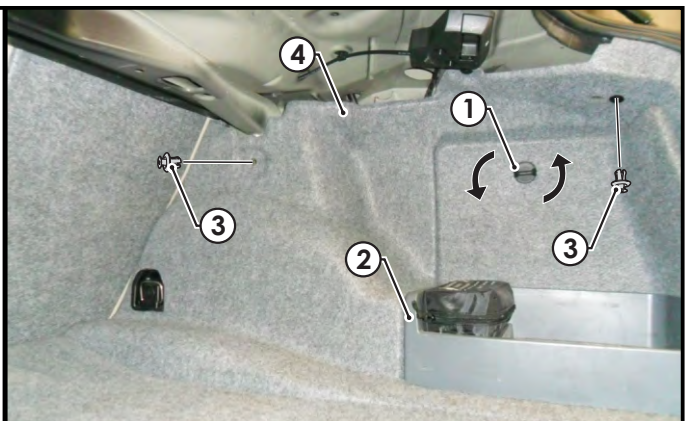

Issue Date 10-12-13

Page 7

Part No: 100854-WL

Hayman Reese (Cequent)  
PO Box 4050, Dandenong South VIC 3164  
Phone 1800 812 017 Email [info@haymanreese.com.au](mailto:info@haymanreese.com.au)

[www.haymanreese.com.au](http://www.haymanreese.com.au)



**HAYMAN REESE**  
**PART No: 100854-WL**  
**BMW X1, 3 Series, X5, X6**

**INSTALLATION INSTRUCTIONS**

PLEASE ENSURE THAT INSTRUCTIONS ARE UNDERSTOOD PRIOR TO FITMENT

5. On the RHS rear quarter panel inside the luggage compartment, remove the vehicle blanking grommet.

**Note: If existing grommet hole is occupied, drill a Ø30mm (1) in the location shown.**

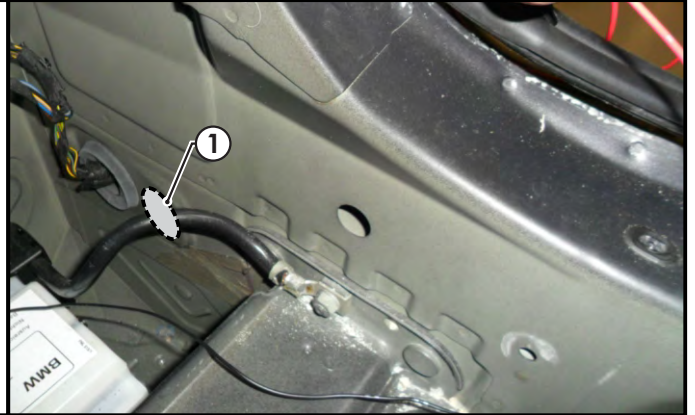

6. Following the table below, connect the ezy-tap (1) to the vehicle harness wire (2), then connect the trailer harness terminal (3) to the ezy-tap (1).

Function	Trailer Patch	Vehicle Connector
L.IND	YELLOW / BLACK	BLUE / GREEN

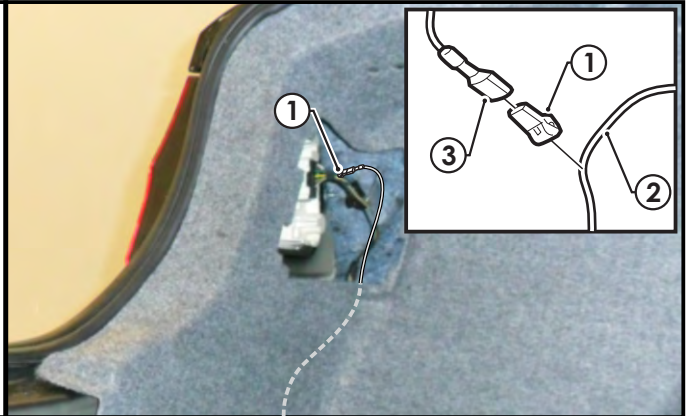

7. Route the trailer patch (P/No: 100854-WL) (1) along the rear of the luggage compartment towards the RHS.

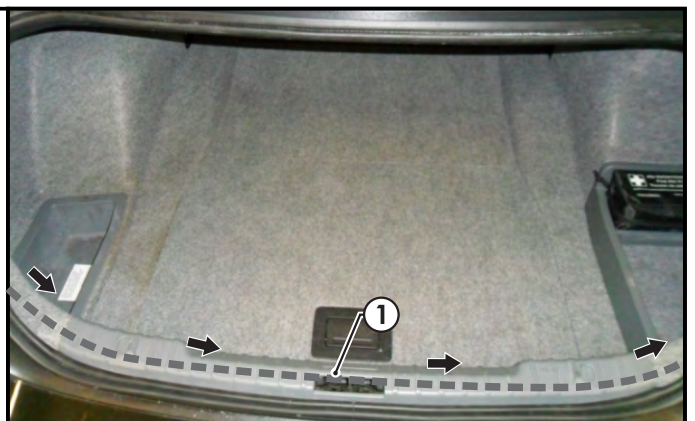

Issue Date 10-12-13

Page 8

Part No: 100854-WL

Hayman Reese (Cequent)  
 PO Box 4050, Dandenong South VIC 3164  
 Phone 1800 812 017 Email [info@haymanreese.com.au](mailto:info@haymanreese.com.au)



**HAYMAN REESE**  
**PART No: 100854-WL**  
**BMW X1, 3 Series, X5, X6**

**INSTALLATION INSTRUCTIONS**

PLEASE ENSURE THAT INSTRUCTIONS ARE UNDERSTOOD PRIOR TO FITMENT

8. On the RHS of the luggage compartment, following the table below, connect the ezy-taps (1) to the vehicle harness wires (2), then connect the trailer harness terminals (3) to the corresponding wires (2).

Function	Trailer Patch	Vehicle Connector
R.IND	GREEN/BLACK	BLUE/BROWN
REVERSE	BLACK/WHITE	BLACK/PURPLE
TAIL/BRAKE	BROWN/BLACK X1 / 3 SERIES	BLACK/BLUE

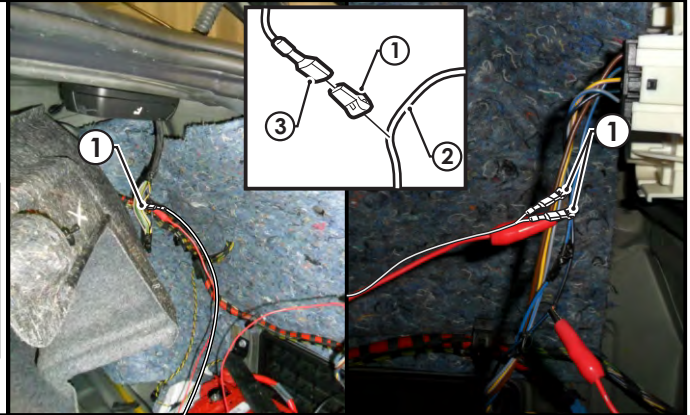

9. Connect the trailer patch power ring terminal (1) to the vehicle battery positive terminal (2).  
 10. Connect the trailer patch ground ring terminal (3) to the vehicle battery negative terminal (4).

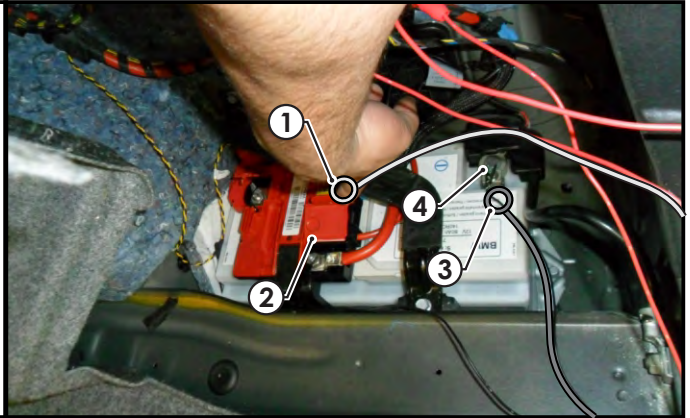

11. Connect the trailer patch 12-way connector (1) to the ECU (04838) (2).

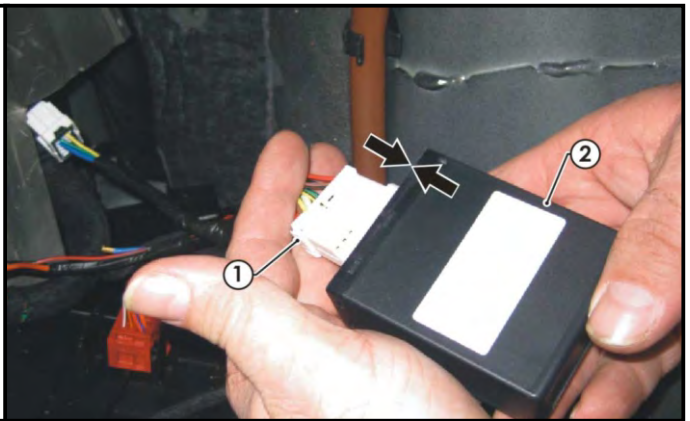

Issue Date 10-12-13

Page 9

Part No: 100854-WL

Hayman Reese (Cequent)  
 PO Box 4050, Dandenong South VIC 3164  
 Phone 1800 812 017 Email [info@haymanreese.com.au](mailto:info@haymanreese.com.au)

[www.haymanreese.com.au](http://www.haymanreese.com.au)



**HAYMAN REESE**  
**PART No: 100854-WL**  
**BMW X1, 3 Series, X5, X6**

**INSTALLATION INSTRUCTIONS**

PLEASE ENSURE THAT INSTRUCTIONS ARE UNDERSTOOD PRIOR TO FITMENT

12. Apply double sided tape to the ECU (1) and adhere it to the vehicle sheet metal (2) on the RHS of the rear quarter panel of the luggage compartment.

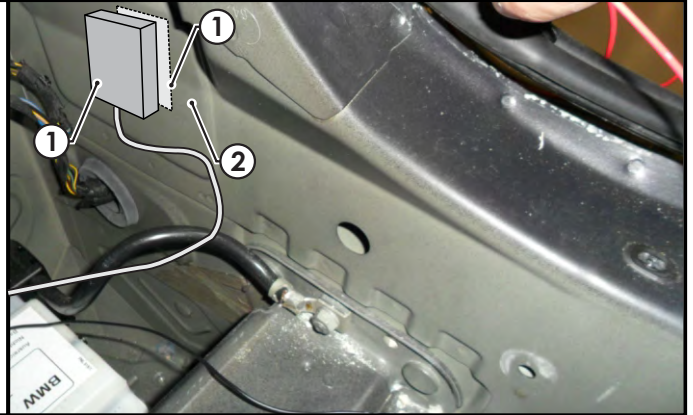

13. Route the tail harness (tail length 1200mm) (1) through the previously drilled out grommet hole towards the towbar.
14. Mount the trailer socket (2) to the towbar mounting bracket using M4 fasteners (not supplied).
15. Ensure the tail harness grommet is seated correctly and secure in place using a cable tie (not supplied).



16. Connect the trailer harness 8-way connector (1) to the tail harness mating connector (2).

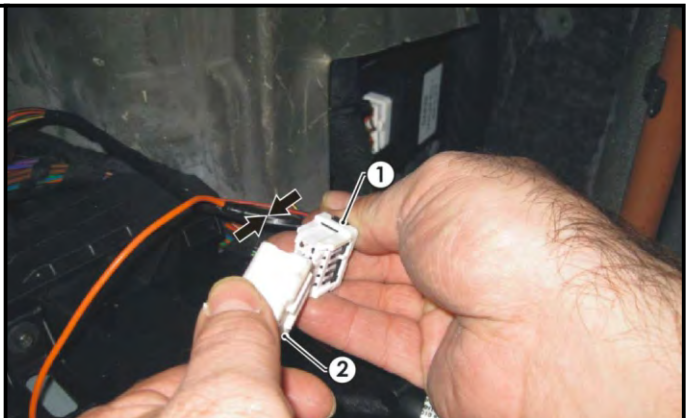

Issue Date 10-12-13

Page 10

Part No: 100854-WL

Hayman Reese (Cequent)  
PO Box 4050, Dandenong South VIC 3164  
Phone 1800 812 017 Email [info@haymanreese.com.au](mailto:info@haymanreese.com.au)

**HAYMAN REESE**  
**PART No: 100854-WL**  
**BMW X1, 3 Series, X5, X6**

**INSTALLATION INSTRUCTIONS**

PLEASE ENSURE THAT INSTRUCTIONS ARE UNDERSTOOD PRIOR TO FITMENT

- |  |  |
|--|--|
| <ol style="list-style-type: none"><li>17. Test the trailer harness function using a Light Board or multimeter.</li><li>18. Secure all harness using cable ties (not supplied).</li><li>19. Re-fit removed parts and secure all fasteners, ensuring there are no squeaks or rattles.</li><li>20. Place instructions in glove box after fitment.</li></ol> |  |
|--|--|

Issue Date 10-12-13

Page 11

Part No: 100854-WL

Hayman Reese (Cequent)  
PO Box 4050, Dandenong South VIC 3164  
Phone 1800 812 017 Email [info@haymanreese.com.au](mailto:info@haymanreese.com.au)

[www.haymanreese.com.au](http://www.haymanreese.com.au)



**HAYMAN REESE**  
**PART No: 100854-WL**  
**BMW X1, 3 Series, X5, X6**

## INSTALLATION INSTRUCTIONS

PLEASE ENSURE THAT INSTRUCTIONS ARE UNDERSTOOD PRIOR TO FITMENT

The following steps are for BMW X5 & X6 models only. For X1 models, please refer to page 2. For 3 Series, please proceed to page 7.

1. In the luggage compartment, remove the floor carpet cover (1).
2. Remove the LHS & RHS access panel covers (2).



3. Remove the tool storage tray (1) by first removing the fasteners.



4. Remove the LHS storage compartment (1).



Issue Date 10-12-13

Page 12

Part No: 100854-WL

Hayman Reese (Cequent)  
PO Box 4050, Dandenong South VIC 3164  
Phone 1800 812 017 Email [info@haymanreese.com.au](mailto:info@haymanreese.com.au)



**HAYMAN REESE**  
**PART No: 100854-WL**  
**BMW X1, 3 Series, X5, X6**

## INSTALLATION INSTRUCTIONS

PLEASE ENSURE THAT INSTRUCTIONS ARE UNDERSTOOD PRIOR TO FITMENT

5. Remove the RHS storage compartment (1).

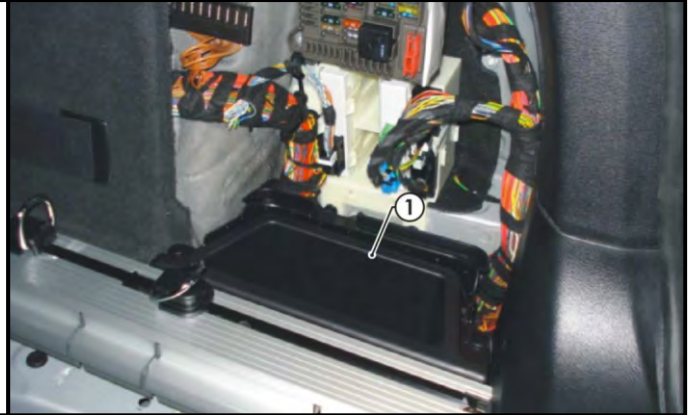

6. In the RHS of the luggage compartment, lift up the carpet cover and remove the vehicle grommet (1).

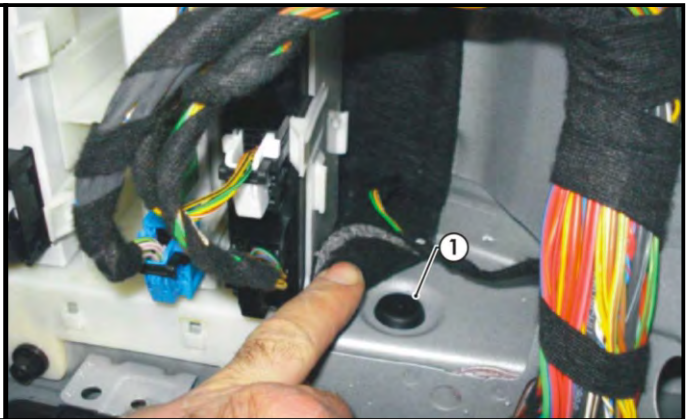

7. From the outside of the vehicle, drill our the grommet hole (1) to Ø30mm. File any rough or sharp edges and spray on rust inhibitor.

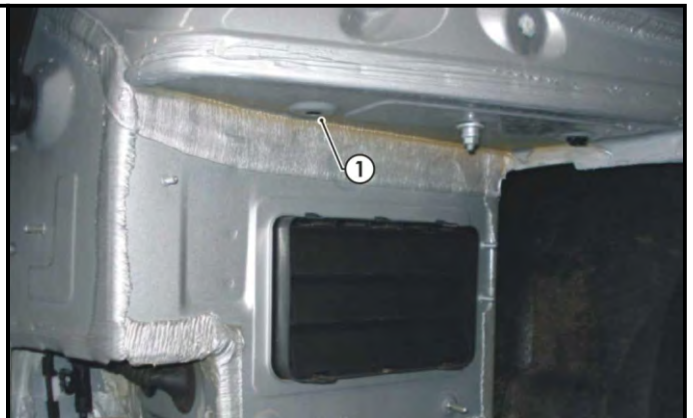

Issue Date 10-12-13

Page 13

Part No: 100854-WL

Hayman Reese (Cequent)  
PO Box 4050, Dandenong South VIC 3164  
Phone 1800 812 017 Email [info@haymanreese.com.au](mailto:info@haymanreese.com.au)

# HAYMAN REESE

## PART No: 100854-WL

### BMW X1, 3 Series, X5, X6

## INSTALLATION INSTRUCTIONS

PLEASE ENSURE THAT INSTRUCTIONS ARE UNDERSTOOD PRIOR TO FITMENT

8. Following the table below, connect the ezy-tap (1) to the vehicle harness wire (2) and then connect the trailer harness terminal (3) to the corresponding wire (2).

Function	Trailer Patch	Vehicle Connector
L.IND	YELLOW / BLACK	BLUE / BROWN

**For MY10 X5 vehicles:**

Function	Trailer Patch	Vehicle Connector
L.IND	YELLOW / BLACK	GREEN / BLUE

**For MY13 vehicles:**

Function	Trailer Patch	Vehicle Connector
L.IND	YELLOW / BLACK	BLACK / WHITE

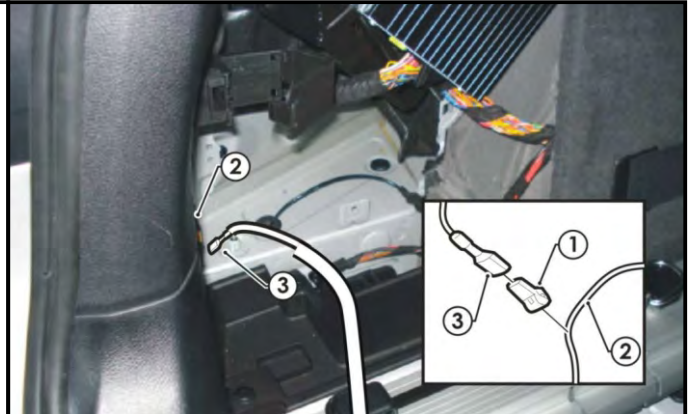

9. Route the trailer patch (P/No: 100854-WL) (1) along the vehicle harness towards the RHS tail light connector.



10. Following the table below, connect the ezy-taps (1) to the vehicle harness wires (2) and then connect the trailer harness terminals (3) to the corresponding wires (2).

Function	Trailer Patch	Vehicle Connector
R.IND	GREEN / BLACK	BLUE / BROWN
REVERSE	BLACK / WHITE	BLACK / YELLOW
TAIL	BROWN / BLACK (X5 & X6)	YELLOW / PURPLE
BRAKES	RED / BLACK	BLACK / WHITE

**For MY10 X5 Vehicles:**

Function	Trailer Patch	Vehicle Connector
R.IND	GREEN / BLACK	BLUE / BROWN
REVERSE	BLACK / WHITE	BLUE / YELLOW
TAIL	BROWN / BLACK (X5 & X6)	YELLOW / PURPLE
BRAKES	RED / BLACK	BLACK / BLUE

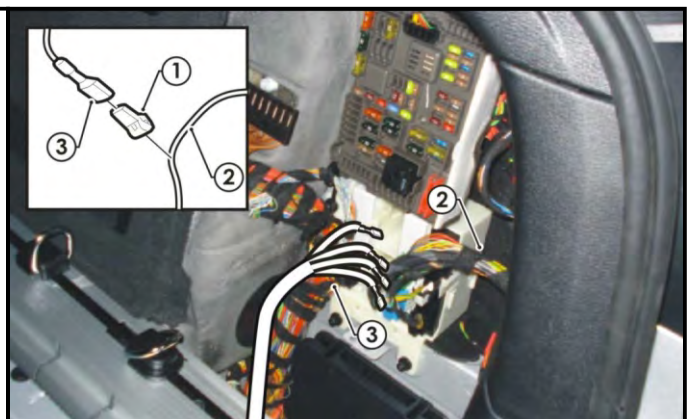

Issue Date 10-12-13

Page 14

Part No: 100854-WL

Hayman Reese (Cequent)

PO Box 4050, Dandenong South VIC 3164

Phone 1800 812 017 Email [info@haymanreese.com.au](mailto:info@haymanreese.com.au)

**HAYMAN REESE**  
**PART No: 100854-WL**  
**BMW X1, 3 Series, X5, X6**

**INSTALLATION INSTRUCTIONS**

PLEASE ENSURE THAT INSTRUCTIONS ARE UNDERSTOOD PRIOR TO FITMENT

11. Following the table below, connect the ezy-taps (1) to the vehicle harness wires (2) and then connect the trailer harness terminals (3) to the corresponding wires (2).

**For MY13 vehicles:**

Function	Trailer Patch	Vehicle Connector
R.IND	BLACK / GREY	BLUE / BROWN
REVERSE	GREY / YELLOW	BLACK / YELLOW
TAIL	BLACK / BLUE	YELLOW / PURPLE
BRAKES	WHITE / BLACK	BLACK / WHITE

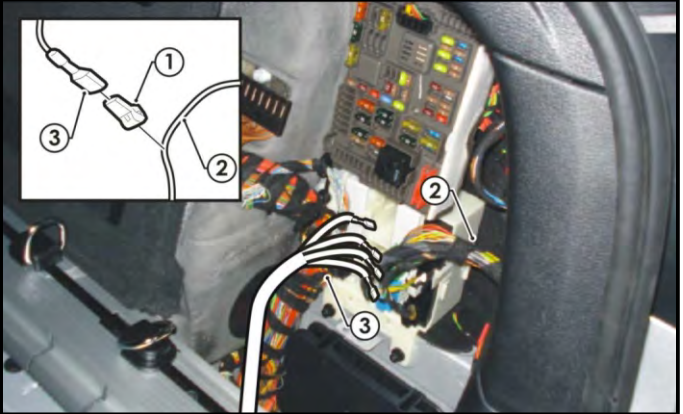

12. Connect the trailer patch 12-way connector (1) to the ECU (No: 04829) (2).

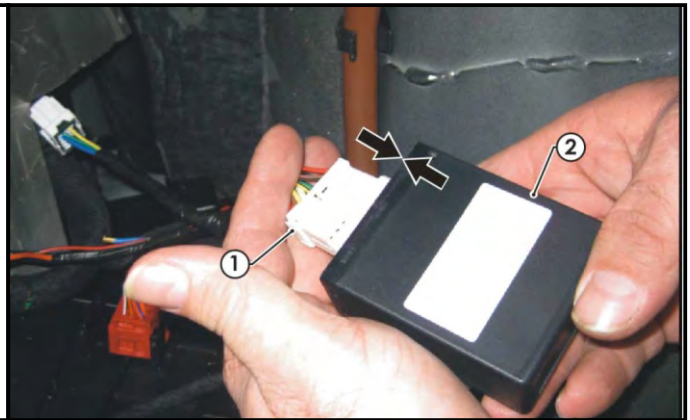

13. Slot the ECU (1) into the vacant slot underneath the fuse panel.

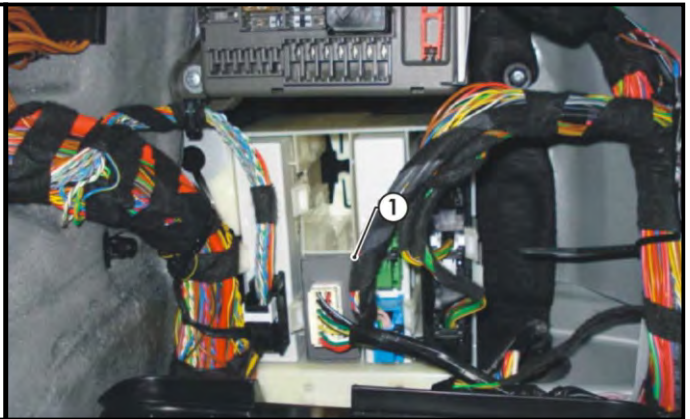

Issue Date 10-12-13

Page 15

Part No: 100854-WL

Hayman Reese (Cequent)  
 PO Box 4050, Dandenong South VIC 3164  
 Phone 1800 812 017 Email [info@haymanreese.com.au](mailto:info@haymanreese.com.au)

**HAYMAN REESE**  
**PART No: 100854-WL**  
**BMW X1, 3 Series, X5, X6**

**INSTALLATION INSTRUCTIONS**

PLEASE ENSURE THAT INSTRUCTIONS ARE UNDERSTOOD PRIOR TO FITMENT

14. Connect the trailer patch 8-way connector (1) to the tail harness (tail length 1800mm) mating connector (2).

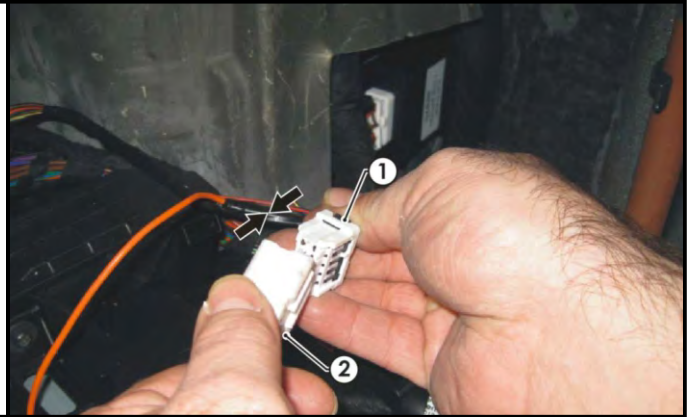

15. Remove the existing vehicle 20-amp fuse (1).  
16. Slot the supplied 20-amp fuse (2) into the upper slot of the add-a-fuse harness (3).  
17. Slot the existing vehicle 20-amp fuse (1) into the lower slot of the add-a-fuse harness (3).  
18. Connect the add-a-fuse harness (4) to the mating trailer wiring harness connector (5).  
19. Insert the add-a-fuse harness fuse connector (3) into the vacant slot.

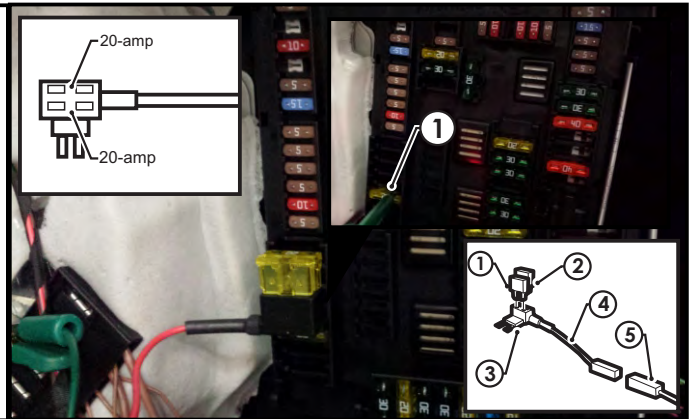

20. Route the tail harness (1) through the previously drilled grommet hole towards the towbar.  
21. Mount the trailer socket (2) to the towbar mounting bracket using M4 fasteners (not supplied).  
22. Ensure the tail harness grommet is seated correctly and secure in place using a cable tie (not supplied).

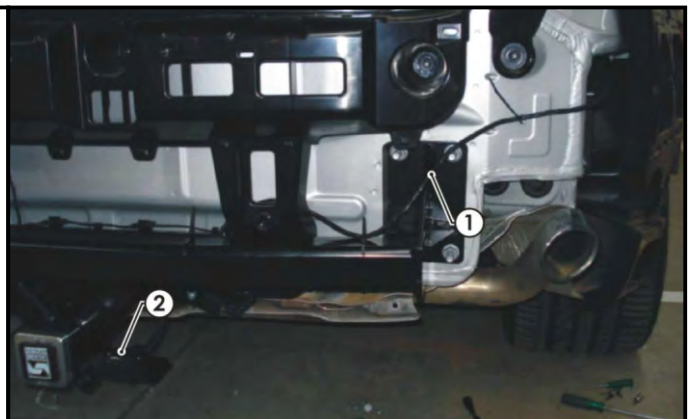

Issue Date 10-12-13

Page 16

Part No: 100854-WL

Hayman Reese (Cequent)  
PO Box 4050, Dandenong South VIC 3164  
Phone 1800 812 017 Email [info@haymanreese.com.au](mailto:info@haymanreese.com.au)

**HAYMAN REESE**  
**PART No: 100854-WL**  
**BMW X1, 3 Series, X5, X6**

**INSTALLATION INSTRUCTIONS**

PLEASE ENSURE THAT INSTRUCTIONS ARE UNDERSTOOD PRIOR TO FITMENT

- |  |  |
|--|--|
| <ul style="list-style-type: none"><li>23. Test the trailer harness function using a Light Board or multimeter.</li><li>24. Secure all harnesses using cable ties (not supplied).</li><li>25. Re-fit all removed parts and secure all fasteners, ensuring there are no squeaks or rattles.</li><li>26. Place instructions in glove box after fitment.</li></ul> |  |
|--|--|

Issue Date 10-12-13

Page 17

Part No: 100854-WL

Hayman Reese (Cequent)  
PO Box 4050, Dandenong South VIC 3164  
Phone 1800 812 017 Email [info@haymanreese.com.au](mailto:info@haymanreese.com.au)

[www.haymanreese.com.au](http://www.haymanreese.com.au)

