

TRAILBOSS

Towbar Fitting Instructions To Suit **HYUNDAI i20 2012** on Part Number **HY29L** Rating **1000/100 kg**

PLACE THESE INSTRUCTIONS IN THE VEHICLE'S GLOVEBOX AFTER INSTALLATION IS COMPLETE

WARNING:

1. Do not, drill, cut, weld or otherwise modify the tow bar.
2. If you are using electric welding on a motor vehicle, **always** check that the vehicle is not equipped with electronic engine or instrument management equipment. Failure to do so could **destroy** any onboard computers. If in doubt, check with the vehicle's manufacturer.
3. The high tensile fasteners supplied with this product were used to achieve the specified rating. If replacement is required ensure that fasteners of the same rating & quality are used. Contact an authorised **Trailboss** dealer if further information is required.

General:

1. Ensure all hardware items have been included refer to assembly diagram.
2. It is recommended that the instructions are read through and completely understood before making any attempt to fit this product.
3. Be wary of any changes to vehicle designs or other accessories that may conflict with the installation of this product.
4. Before drilling ensure that the area is clear of fuel, electrical & other components.
5. All holes drilled into the body panels shall have all burrs & swarf removed then coated with a suitable rust preventative paint.
6. For vehicles that require the bumper to be cut. Ensure cut out area is in correct position on the vehicle prior to cutting the bumper.
7. The high tensile fasteners supplied with this product were used to achieve the specified rating. If replacement is required ensure that fasteners of the same rating & quality are used. Contact an authorized **Trailboss** dealer if further information is required.
8. Ensure that all hardware is fastened to torque list below check fasteners on regular basis.
9. Tow bar load rating sticker provided with this product shall be conspicuously located on inside rear end of the driver's door. **(See diagram below)**.
10. Trailboss recommends that you check your tow ball to ensure that it complies with the Australian standards **AS 4177.2**.
11. **PLEASE NOTE:** It is advised to remove your lug or tbm when not actually towing so as to produce a clear view of the vehicles registration plate if obscured, and to also provide maximum available departure angle
12. Pull Pin must be fit in down position.

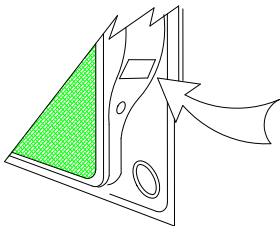

Place load rating sticker
inside driver's door here

FOR TRAILER TOWING PURPOSES ONLY
For towing capacity details please refer to vehicle owner's manual or to the manufacturer. Overloading can void your warranties.

RECOMMENDED ASSEMBLY TORQUE LISTING

Diameter	Grade 8.8 Bolt
M6	9.5 Nm
M8	21.7 Nm
M10	43.4 Nm
M12	77.3Nm
M14	146 Nm
M16	189.8 Nm

Tow bar Maintenance and Care.

Trailboss recommends that bolt torque's, as listed below, are routinely and regularly inspected and checked for correct tension. Replace any worn or defective parts.

We recommended to remove Tow Ball Mounts (TBM's, tongues or lugs) when not being used for any considerable length of time.

So as to avoid injury, when not towing it is suggested that the tongue, Pull Pin and R-clip are removed then stored in a safe, clean and dry place, away from excessive moisture.

Hitch Pull Pins and spring "R" clips are regularly checked for proper installation. Replace any worn or defective parts.

TRAILBOSS

Towbar Fitting Instructions
 To Suit **HYUNDAI i20 2012** on
 Part Number **HY29L**
 Rating **1000/100 kg**

PLACE THESE INSTRUCTIONS IN THE VEHICLE'S GLOVEBOX AFTER INSTALLATION IS COMPLETE

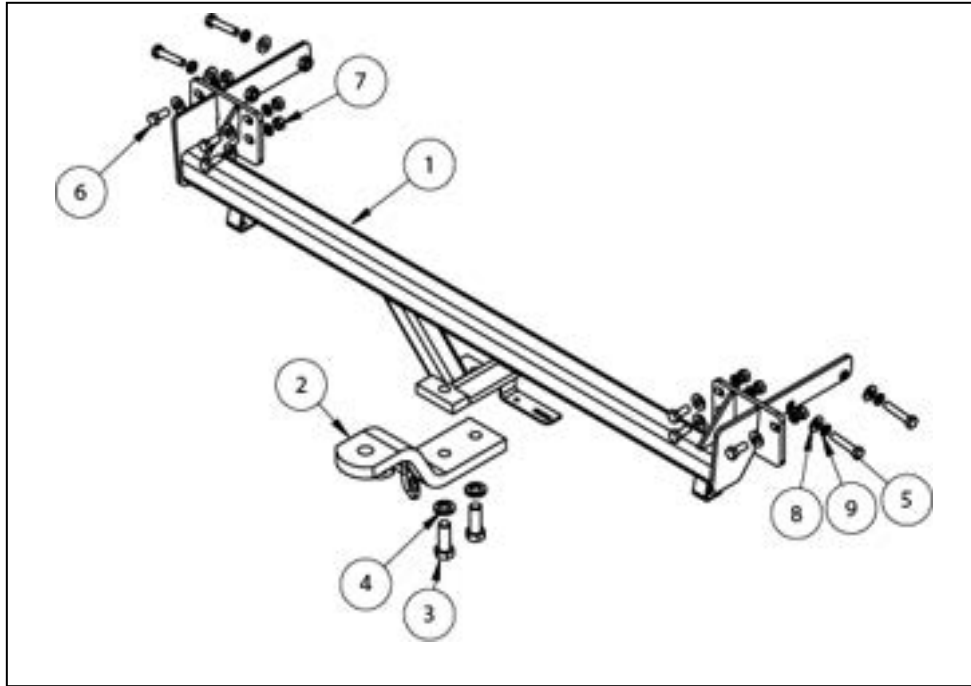

QTY	DESCRIPTION	ITEM NO
1	WELDED ASSEMBLY	1
1	WELDED LUG ASSEMBLY	2
2	M16 x45 2.0P BOLT	3
2	M16x5x3.5 SPRING WASHER	4
4	BOLT M10x1.5x50	5
6	BOLT M10-1.5x25	6
6	NUT HX M10-1.5 Z/P	7
10	WASHER FLAT M10x23x2 Z/P	8
10	M10x3.5x2.2 SPRING WASHER	9

ADDITIONAL ITEMS



FITTING INSTRUCTION



WIRING LOOM



CP LABEL



LOAD RATING LABEL



Towbar Fitting Instructions
To Suit **HYUNDAI i20 2012** on
Part Number **HY29L**
Rating **1000/100 kg**

PLACE THESE INSTRUCTIONS IN THE VEHICLE'S GLOVEBOX AFTER INSTALLATION IS COMPLETE

INSTRUCTION:

1. Remove 9 Scrivets from the underneath the Bumper.
2. Remove 2 Scrivets and 1 Screw from the Side Wheel Arch. Repeat the step on the other side.
3. Remove 2 Screws and remove the light. Detach 4 Bulbs before removing the Light. Repeat the step on the other side.
4. Remove 2 Scrivets and 1 Screw from inside the light. Repeat the step on the other side.
5. Remove 2 Bolts holding the Impact Beam from inside, next to the Chassis Rail. Repeat the step on the other side. Flex the Bumper out, and remove carefully.
6. Remove 2 Scrivets from top and bottom tabs, to remove the Impact Beam, with the tabs. Repeat the step on the other side.
7. Locate the Towbar on the vehicle. Locate the Chassis Rail holes and fit loosely 2 M10 Bolts, 2 Spring Washers and 2 Flat Washers on the both sides. Fit 3 M10 Bolts, 3 Flat Washers, 3 Spring Washers and 3 M10 Nut on the back Panel.
8. Torque the Bolts to the Torque requirements as shown on page1.
9. Refit the Bumper Bar.



Wiring Loom Fitting Instructions
To Suit Hyundai i20 (06/2012 – Onwards)
Part Number 100849-WL

Wiring Loom Installation Instructions

Hyundai i20
(06/2012 – Onwards)

Part No: 100849-WL
ECU Required: 04826

Tail Harness Length Required: 1200mm

Wiring Loom Installation Time: Approx 20 Mins

Wiring Loom Fitting Instructions To Suit Hyundai i20 (06/2012 – Onwards) Part Number 100849-WL

1. In the luggage compartment, remove the parcel shelf.
2. Fold the rear seats forward.
3. Remove the luggage compartment rear trim by first removing the two clips.
4. On the luggage compartment LHS side trim, remove the two Phillips head screws.

Repeat for the RHS.

5. Dislodge the LHS trim panel light and disconnect the trim panel light connector.
6. Inside the vehicle, remove the RHS rear passenger seat base by pulling towards the front in an upwards direction.
7. Using a trim removal tool, dislodge the rear passenger RHS 'C' pillar trim.
8. Remove the RHS lower seat trim by first removing the two fasteners.
9. Remove the driver's door scuff plate.
10. In the driver's footwell, remove the kick panel lever by first removing the fastener.
11. Dislodge the kick panel trim.
12. Remove the lower dash board trim to gain access to the fuse panel.
13. In the LHS rear quarter corner, remove the vehicle blanking grommet (1) and drill out the hole to Ø30mm.
14. File any rough or sharp edges and spray on rust inhibitor.

Note: If grommet (1) is occupied, drill a Ø30mm (2) in the location shown.





Wiring Loom Fitting Instructions
To Suit Hyundai i20 (06/2012 – Onwards)
Part Number 100849-WL

15. Dislodge the LHS luggage compartment trim, enough to expose the LHS tail light connectors.
16. Disconnect the tail light connectors.
17. Connect the trailer harness patch connectors between the tail light assembly connectors.
18. Apply double sided tape to the ECU (04826) and adhere it to the vehicle sheet metal in a suitable location on the LHS of the luggage compartment.
19. Connect the trailer patch 12-way connector to the ECU.
20. Connect the trailer patch ground ring terminal to the vehicle grounding point.
21. Route the trailer harness across the rear of the luggage compartment toward the RHS of the vehicle.
22. Dislodge the RHS side trim enough to expose the RHS tail light connectors.
23. Disconnect the tail light connectors.
24. Connect the trailer harness patch connector between the tail light assembly connectors.
25. Route the 'ORANGE' power wire along the existing vehicle harness towards the front of the vehicle.
26. Continue routing the 'ORANGE' power wire along the existing vehicle harness towards the fuse panel.

Wiring Loom Fitting Instructions To Suit Hyundai i20 (06/2012 – Onwards) Part Number 100849-WL

27. Inside the fuse panel, locate & remove the 15-amp fuse as shown (1).

28. Insert the supplied 15-amp (2) & 30-amp (3) fuses into the add-a-fuse (4).

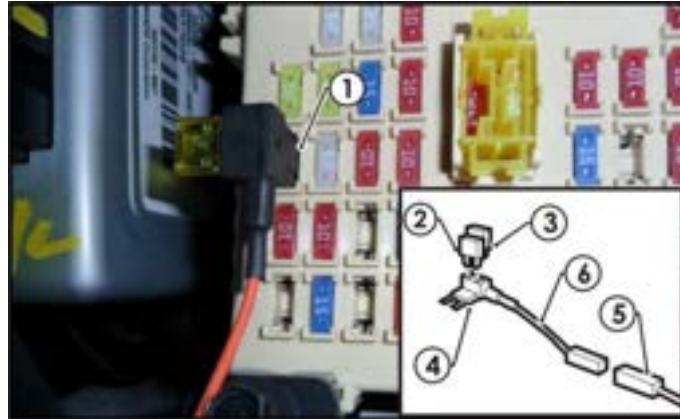

29. Plug the add-a-fuse (4) into the previously removed 15-amp fuse slot (1).

30. Connect the power patch 1-way connector (5) into the add-a-fuse harness mating connector (6).

31. Mount the trailer socket to the tow bar mounting bracket using M4 fasteners (not supplied).

32. Route the tail harness across the tow bar towards the LHS of the vehicle and up through the previously drilled out hole.

33. Ensure the tail harness grommet is seated correctly and secure in place using a cable tie (not supplied).

34. Connect the tail harness (tail length 1200mm) 8-way connector to the trailer patch mating 8-way connector.

35. Test the trailer patch function using a light board or multi meter.

36. Secure all harnesses using cable ties (not supplied).

37. Re-fit all removed parts and secure all fasteners, ensuring there are no squeaks or rattles.

38. Place the fitting instructions in the glove box after fitment.